

- there are many hazards that may affect the performance of the equipment and corresponding safety precautions that have to be observed during equipment utilization, especially:
 - trailing or looping of lanyards or lifelines over sharp edges,
 - any defects like cutting, abrasion, corrosion,
 - climatic exposure,
 - pendulum falls,
 - extremes of temperature,
 - chemical reagents,
 - electrical conductivity.
- personal protective equipment must be transported in the package (e.g.: bag made of moisture-proof textile or foil bag or cases made of steel or plastic) to protect it against damage or moisture.
- the equipment can be cleaned without causing adverse effect on the materials in the manufacture of the equipment. For textile products use mild detergents for delicate fabrics, wash by hand or in a machine and rinse in water. Plastic parts can be cleaned only with water. When the equipment becomes wet, either from being in use or when due cleaning, it shall be allowed to dry naturally, and shall be kept away from direct heat. In metallic products some mechanic parts (spring, pin, hinge, etc.) can be regularly slightly lubricated to ensure better operation. Other maintenance and cleaning procedures should be adhered to detailed instructions stated in the manual of the equipment.
- personal protective equipment should be stored loosely packed, in a well-ventilated place, protected from direct light, ultraviolet degradation, damp environment, sharp edges, extreme temperatures and corrosive or aggressive substances.

IT IS THE RESPONSIBILITY OF THE USER ORGANISATION TO PROVIDE THE IDENTITY CARD AND TO FILL IN THE DETAILS REQUIRED.

THE IDENTITY CARD SHOULD BE FILLED IN BEFORE THE FIRST USE BY A COMPETENT PERSON, RESPONSIBLE IN THE USER ORGANIZATION FOR PROTECTIVE EQUIPMENT.

ANY INFORMATION ABOUT THE EQUIPMENT LIKE PERIODIC INSPECTIONS, REPAIRS, REASONS OF EQUIPMENT'S WITHDRAWN FROM USE SHALL BE NOTED INTO THE IDENTITY CARD BY A COMPETENT PERSON.

THE IDENTITY CARD SHOULD BE STORED DURING A WHOLE PERIOD OF EQUIPMENT UTILIZATION.

DO NOT USE THE EQUIPMENT WITHOUT THE IDENTITY CARD.

ALL RECORDS IN THE IDENTITY CARD CAN BE FILLED IN ONLY BY A COMPETENT PERSON.

IDENTITY CARD

MODEL AND TYPE OF EQUIPMENT	
REF. NUMBER	
SERIAL NUMBER	DATE OF MANUF.
USER NAME	
DATE OF PUTTING INTO OPERATION	
DATE OF PURCHASE	

PERIODIC EXAMINATION AND REPAIR HISTORY

	DATE	REASON FOR ENTRY PERIODIC EXAMINATION OR REPAIR	DEFECTS NOTED, REPAIRS CARRIED OUT AND OTHER RELEVANT INFORMATIONS	NAME AND SIGNATURE OF COMPETENT PERSON	PERIODIC EXAMINATION NEXT DUE DATE
1					
2					
3					
4					

EC type examination carried out by CETE APAVE SUDEUROPE, BP 193, 13322 Marseille, France - 0082

PROTEKT, 93-403 LODZ, ul. Starorudzka 9, POLAND, TEL: (48 42) 680 20 83, FAX: (48 42) 680 20 93, www.protekt.com.pl

Instruction Manual

EN 361:2002 **CE** 0082 Ref. AB 160 01 - P-60
 EN 358:2000 Ref. AB 160 02 - P-60E

PROTEKT® Safety Harness P-60/60E

Safety harness is basic of fall arrest equipment and complies with EN 361 and EN 358.

DESCRIPTION

Full body harness P-60 is made of pieces of polyamide webbing which are sewn and connected by metal buckles.

This configuration guarantee full safety and comfort work.

BASIC EQUIPMENT

- back attaching buckle** - for attaching fall arrest system;
- front attaching loops** - for attaching fall arrest system;
- connecting and adjusting buckles** - for comfort wearing and using of harness;
- work positioning belt.**

SIZES

The harness P-60 is manufactured in two sizes:

- universal: M-XL
- extra large: XXL

ADMISSIBLE TIME OF USE

Safety harness can be used for 5 years counting from a date of putting the harness into operation. After this period the harness must be withdrawn from use to carry out manufacturer's detailed inspection.

The manufacturer's inspection can be carried out by:

- manufacturer
- or person recommended by manufacturer
- or company recommended by manufacturer.

During this inspection will be established admissible time of harness use till next manufacturer's inspection.

The harness must be withdrawn from use immediately and destroyed when it has been used to arrest a fall.

CONTENT OF HARNESS IDENTITY LABEL

trade mark of the device

type of the device

reference number

size

month/year of the device manufacture

number of the manufacturing series

number / year of the European standards the equipment conform

CE marking and number of a notified body controlling manufacturing of the equipment [art. 11]

caution: read the manual

marking of the manufacturer or distributor

P-60	Size: <input type="checkbox"/> M-XL
SAFETY HARNESS	<input type="checkbox"/> XXL
Ref. AB 160 01	Date of manufacture: 03/2003
	Serial number: 0000001
	EN 361:2002 EN 358:2000
	CE 0082
	PROTEKT®

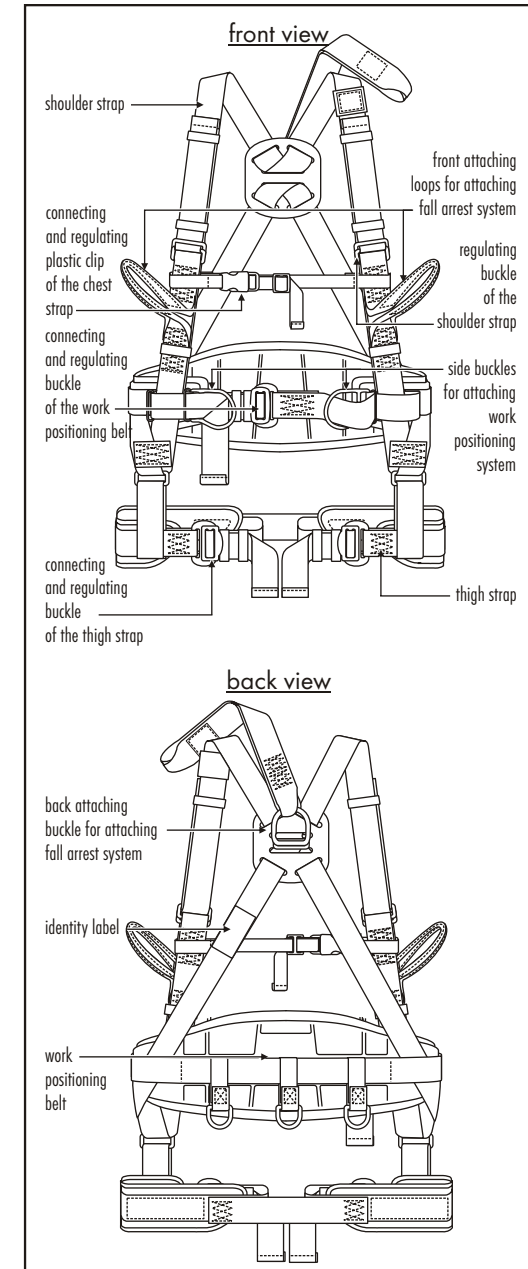

HOW TO PUT ON THE HARNESS

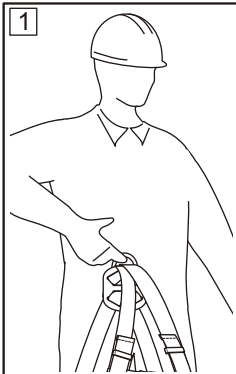

1 Take the harness by the back attaching buckle.

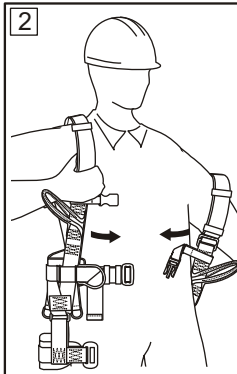

2 Put on the shoulder straps one after one, take care do not twist them.

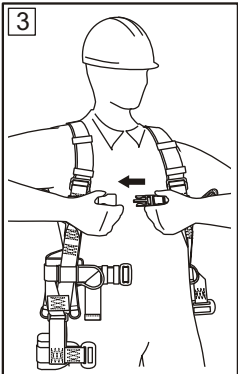

3 Connect front plastic clip and adjust the tension the chest strap.

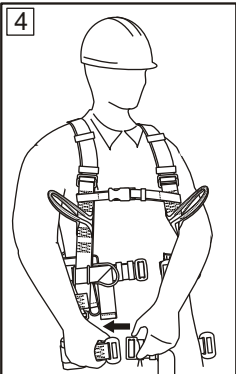

4 Pull one and then other thigh straps through crotch, take care do not twist them.

Connecting of the steel buckles of the thigh straps and work positioning belt

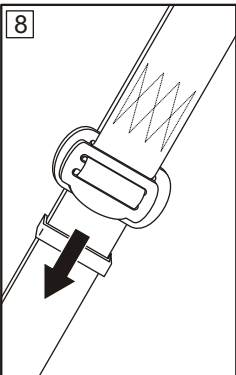
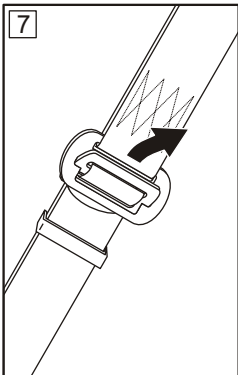
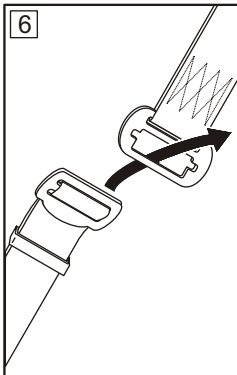

Adjusting the thigh straps and work positioning belt

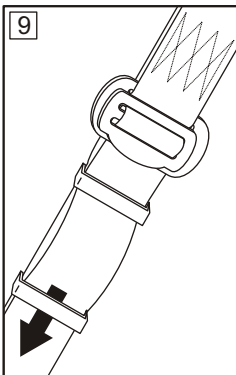

Shortening

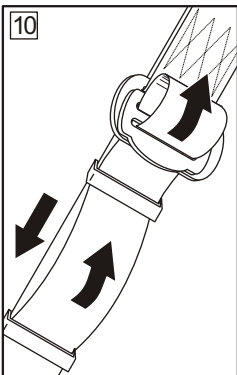

Lengthening

Adjusting the shoulder straps

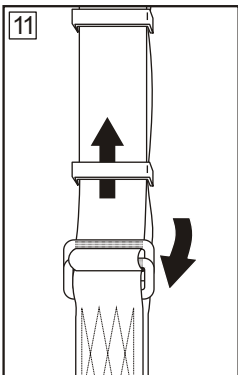

Shortening

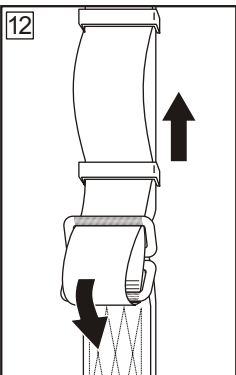

Lengthening

Harness is put on correctly if:

- all straps are correctly adjusted (neither too loose nor too tight).
- back attaching buckle is correctly positioned at the level of the shoulder blades.
- front chest strap is correctly positioned at the middle of the chest.
- the ends of the all straps must be kept by plastic loops.

ATTACHING FALL ARREST SYSTEM

- the fall arrest system must be connected only to the attaching elements of the harness marked by capital letter A.
- The fall arrest system must be connected only to:
 - straight to the back attaching buckle.
 - or
 - to the lengthening element of attaching buckle
 - or
 - to both front attaching loops of the harness. *It is strictly forbidden to attach a fall arrest system to a single loop.*

The back attaching buckle is marked by a capital letter A - marked on the crossing plate with arrows indicating back attaching buckle (1).

Lengthening element is marked by a capital letter A placed on the label inside element loop (2).

Front attaching loops are marked by a capital letter A (one half of letter is black and another half is marked by outline) placed on the label inside each loop (3).

See drawings below.

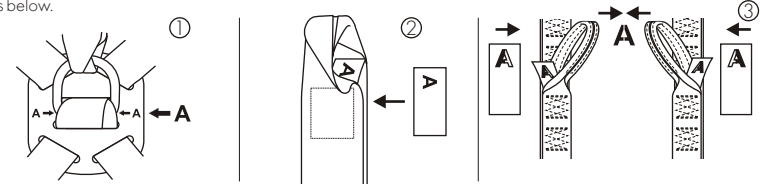

ATTACHING WORK POSITIONING LANYARD

- work positioning system could be attached only to the lateral buckles of the work positioning belt, and according EN 358 - work positioning lanyard must be anchored to the point of construction that is situated at waist level or above. Work positioning lanyard must be kept taut to restrict free movement to a maximum 0,5 m.

WARNING:

- 1) It is strictly forbidden to attach any fall arrest system to side buckle of work positioning belt.
- 2) It is strictly forbidden to attach any work positioning system to front attaching loops or back attaching buckle.

Read carefully before use the equipment

THE ESSENTIAL PRINCIPLES FOR USERS OF PERSONAL PROTECTIVE EQUIPMENT AGAINST FALLS FROM A HEIGHT



- personal protective equipment shall only be used by a person trained and competent in its safe use.
- personal protective equipment must not be used by a person with medical condition that could affect the safety of the equipment user in normal and emergency use.
- a rescue plan shall be in place to deal with any emergencies that could arise during the work.
- it is forbidden to make any alterations or additions to the equipment without the manufacturer's prior written consent.
- any repair shall only be carried out by equipment manufacturer or his certified representative.
- personal protective equipment shall not be used outside its limitations, or for any purpose other than that for which it is intended.
- personal protective equipment should be a personal issue item.
- before use ensure about the compatibility of items of equipment assembled into a fall arrest system. Periodically check connecting and adjusting of the equipment components to avoid accidental loosening or disconnecting of the components.
- it is forbidden to use combinations of items of equipment in which the safe function of any one item is affected by or interferes with the safe function of another.
- before each use of personal protective equipment it is obligatory to carry out a pre-use check of the equipment, to ensure that it is in a serviceable condition and operates correctly before it is used.
- during pre-use check it is necessary to inspect all elements of the equipment in respect of any damages, excessive wear, corrosion, abrasion, cutting or incorrect acting, especially take into consideration:
 - in full body harnesses and belts - buckles, adjusting elements, attaching points, webbings, seams, loops;
 - in energy absorbers - attaching loops, webbing, seams, casing, connectors;
 - in textile lanyards or lifelines or guidelines - rope, loops, thimbles, connectors, adjusting element, splices;
 - in steel lanyards or lifelines or guidelines - cable, wires, clips, ferrules, loops, thimbles, connectors, adjusting elements;
 - in retractable fall arresters - cable or webbing, retractor and brake proper acting, casing, energy absorber, connector;
 - in guided type fall arresters - body of the fall arrester, sliding function, locking gear acting, rivets and screws, connector, energy absorber;
 - in connectors - main body, rivets, gate, locking gear acting.
- after every 12 months of utilization, personal protective equipment must be withdrawn from use to carry out periodical detailed inspection. The periodic inspection must be carried out by a competent person for periodic inspection. The periodic inspection can be carried out also by the manufacturer or his authorized representative.
- In case of some types of the complex equipment e.g. some types of retractable fall arresters the annual inspection can be carried out only by the manufacturer or his authorized representative.
- regular periodic inspections are the essential for equipment maintenance and the safety of the users which depends upon the continued efficiency and durability of the equipment.
- during periodic inspection it is necessary to check the legibility of the equipment marking.
- it is essential for the safety of the user that if the product is re-sold outside the original country of destination the reseller shall provide instructions for use, for maintenance, for periodic examination and for repair in language of the country in which the product is to be used.
- personal protective equipment must be withdrawn from use immediately when any doubt arise about its condition for safe use and not used again until confirmed in writing by equipment manufacturer or his representative after carried out the detailed inspection.
- personal protective equipment must be withdrawn from use immediately and destroyed (or another procedures shall be introduced according detailed instruction from equipment manual) when it have been used to arrest a fall.
- a full body harness is the only acceptable body holding device that can be used in a fall arrest system.
- the anchor device or anchor point for the fall arrest system should always be positioned, and the work carried out in such a way, as to minimise both the potential for falls and potential fall distance. The anchor device/point should be placed above the position of the user. The shape and construction of the anchor device/point shall not allowed to self-acting disconnection of the equipment. Minimal static strength of the anchor device/point is 15 kN. It is recommended to use certified and marked structural anchor point complied with EN795.
- it is obligatory to verify the free space required beneath the user at the workplace before each occasion of use the fall arrest system, so that, in the case of a fall, there will be no collision with the ground or other obstacle in the fall path. The required value of the free space should be taken from instruction manual of used equipment.